

Installation instructions

Facade insulation

Environmentally friendly insulation systems made from natural wood fibres

Technical detailing



Content

The External Thermal Insulation Composite System	3
Notes for the planner	8
General processing instructions	9
Areas of application	14
Wood fibre insulation board on timber substrate	15
Wood fibre insulation board on masonry	26
Processing render components	29
System components product overview	30
Checklist „Transfer of base layer ready for rendering“	33
Further system partners	37



STEICO
engineered by nature



STEICO Engineered by nature

Ecological building materials for every project

The STEICO Group, headquartered in Feldkirchen near Munich, is the world's largest manufacturer of ecological wood fibre insulating materials. For decades STEICO insulation materials have been used to protect buildings around the world against cold, heat, humidity and wind. The extensive range of insulating materials is supplemented by innovative construction products. This makes it possible to obtain the complete load-bearing and insulating building envelope from a single source. Independent tests regularly confirm the high and consistent product quality of STEICO construction products.

Two processes for STEICO wood fibre insulation materials

STEICO wood fibre insulation materials are manufactured exclusively from fresh, untreated coniferous wood from sustainable forestry. The fresh wood is then split into fibres and, depending on the type, further processed in one of the following processes:

Wet process

This process has been tried and tested for decades. Wet wood fibres are pressed to form the boards. The entire board is then dried. The boards are bonded by the wood's own component lignin. No additional binder is added. This makes the panels particularly eco-friendly.

Dry process

Within these processes, the wood fibres are first dried, then wetted with a binding agent and formed into boards. These boards are characterised by their low weight, which is advantageous when large insulation thicknesses are used. STEICO products from the dry process can be identified by the suffix „dry“.

The render boards are offered in different densities with the addition of **Typ L (Light)**, **Typ M (Medium)** and **Typ H (High)** in the product name.

The External Thermal Insulation Composite System

We offer both **STEICO*protect*** or **STEICO*duo*** from the wet process as well as **STEICO*protect dry*** or **STEICO*duo dry*** from the dry process. Both board types are ideally suited for robust constructions and are water repellent as well as vapour open.

The External Thermal Insulation Composite System

ETICS with STEICO render carrying boards

The STEICO system components and accessories complement each other which ensures enhanced system security.

STEICO provides suitable boards for various requirements and working methods in small and large formats as well as with square edges or with tongue and groove. Special formats are available on request.

We offer the render carrying boards **STEICO*protect*** up to 100 mm and **STEICO*protect dry*** up to 240 mm.

STEICO*duo* or **STEICO*duo dry*** are available in our product portfolio, sized 40 and 60 mm respectively.

The render carrying boards are offered in different densities, which are additionally marked as Type L (low), Type M (medium) and Type H (high density).

For any technical questions please contact our application technology department.

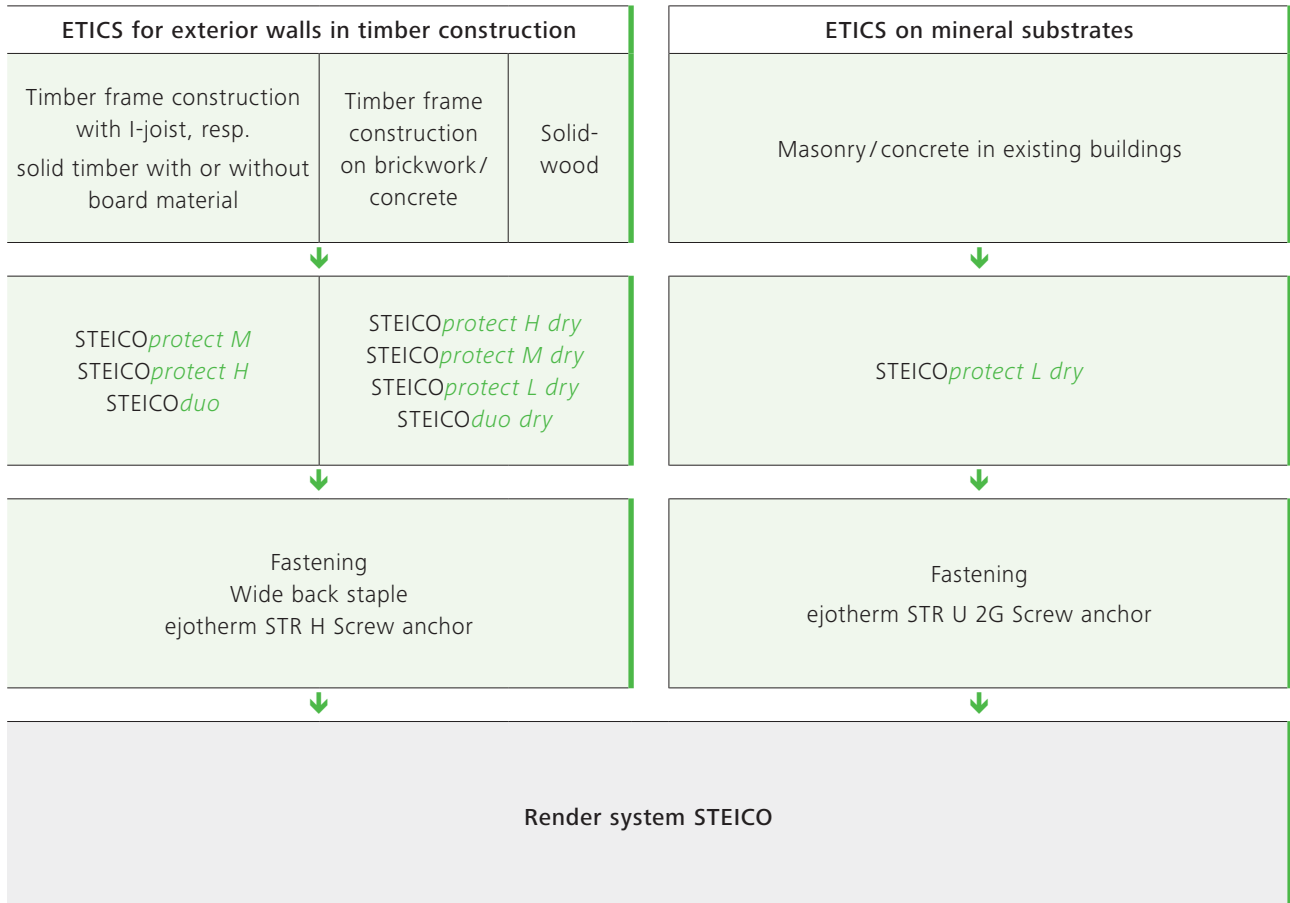

STEICO Timber: Layer structure

For exterior walls in timber construction with STEICO^{wall} / STEICO^{joist} / Solid timber

Due to the high strength properties of STEICO wood fibre insulation boards, they are particularly suitable for use in timber frame construction. The vapour open properties of the wood fibre insulation boards and the render systems enable wall constructions with a high evaporation potential.

The wood fibre insulation boards are mounted directly on the studs of the timber frame construction as external cladding. The studs can be made of STEICO^{wall} / STEICO^{joist} i-beams or solid timber.

The use of a board material between the studs and the STEICO^{protect} / STEICO^{protect dry} is possible based on approval, but it may impair the evaporation potential of the overall construction and is therefore not recommended as a rule.

Energy-efficient structural solutions for outside walls with rendered facade can be found in the "Report on passive house certification": www.steico.com/Passivhaus.



1 Wood fibre insulation board

STEICO^{protect} / STEICO^{protect dry} or STEICO^{duo} / STEICO^{duo dry}

Fastening:

Wide back staple or
ejothem STR H screw dowel

2 Reinforcing mortar

Reinforcing fabric

3 Intermediate coating (optional)

Flex slurries (Base area)
Adhesion promoter

4 Top coat

5 Finish

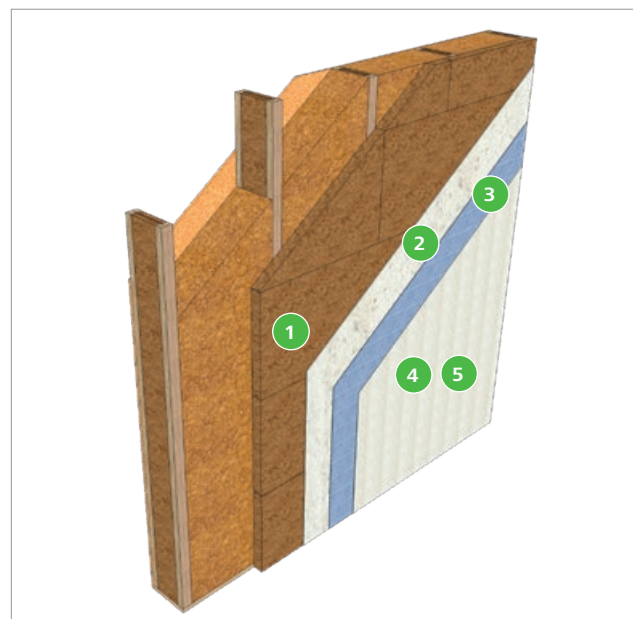

Timber frame constructions without board material outside

The External Thermal Insulation Composite System

Exterior walls made of solid, extensive timber components

Also on solid timber walls (e.g. STEICO *LVL* 30 mm, elements from board stacks, cross laminated timber or glued laminated timber), the use of STEICO wood fibre insulation boards has proved to be very successful. Basically, there are two different types of mounting:

Variant A

Application of an additional compartment level (STEICO*wall* / STEICO*joist*- or solid timber), on which the STEICO*protect* / STEICO*protect dry* / STEICO*duo* / STEICO*duo dry* wood fibre insulation boards can be mounted

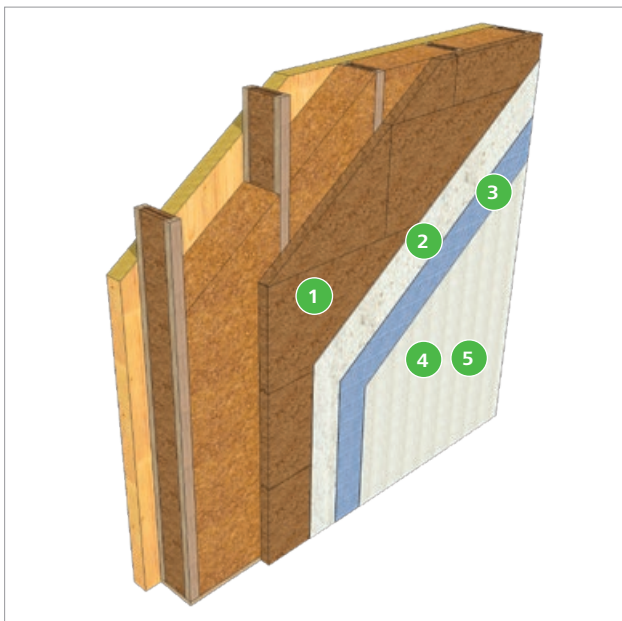

- 1 Wood fibre insulation board**
STEICO*protect* / STEICO*protect dry* oder STEICO*duo* / STEICO*duo dry*
Fastening:
Wide back staple or
ejothem STR H screw dowel
- 2 Reinforcing mortar**
Reinforcing fabric
- 3 Intermediate coating (optional)**
Flex slurries (Base area)
Adhesion promoter
- 4 Top coat**
- 5 Finish**

Variant B

Direct surface mounting of the STEICO*protect dry* / wood fibre insulation boards

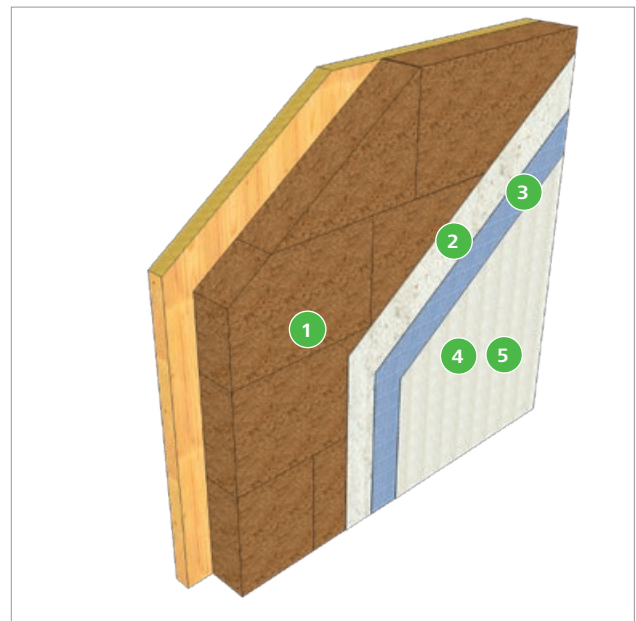

- 1 Wood fibre insulation board**
STEICO*protect* / STEICO*protect dry*
Fastening:
Wide back staple or
ejothem STR H screw dowel
- 2 Reinforcing mortar**
Reinforcing fabric
- 3 Intermediate coating (optional)**
Flex slurries (Base area)
Adhesion promoter
- 4 Top coat**
- 5 Finish**

STEICO Mineral: Layer structure

For existing external wall with a mineral or fully supported substrate

STEICO wood fibre insulation boards can be applied directly to rendered or unrendered masonry or concrete substrates during renovation. The wood fibre insulation boards are fixed to the substrate with adhesive mortar and additional fixings.

- 1 **Adhesive mortar**
- 2 **Wood fibre insulation board**
STEICO*protect dry*
Fastening:
Wide back staple or
ejotherm STR 2G screw anchor
- 3 **Reinforcing mortar**
Reinforcing fabric
- 4 **Intermediate coating (optional)**
Flex slurries (Base area)
Adhesion promoter
- 5 **Top coat**
- 6 **Finish**



The External Thermal Insulation Composite System

Exterior walls made of mineral building materials with additional timber frame construction

STEICO wood fibre insulation boards can be used for renovation and new buildings by means of an additional timber frame construction (compartment level) made of STEICOWall / STEICOjoist I-joint or solid timber cross sections on mineral substrates. Particularly on critical substrates with no longer load-bearing render or uneven surfaces that need to be levelled, renovations can be carried out without costly preparatory measures. Any installation guides (cables, water/heating pipes, connection of solar elements in the roof area) can be laid behind the render baseboard in a thermally protected manner.

The use of robust wood-based materials creates a resilient surface. In combination with air-injected insulating materials such as STEICOzell (wood fibre) or STEICOfloc (cellulose) in the compartments, highly insulated and economical constructions can be created.

Variant A

Application of an additional compartment level (STEICOWall / STEICOjoist-), on which the STEICOprotect/STEICOprotect dry / STEICOduo/STEICOduo dry wood fibre insulation boards can be mounted

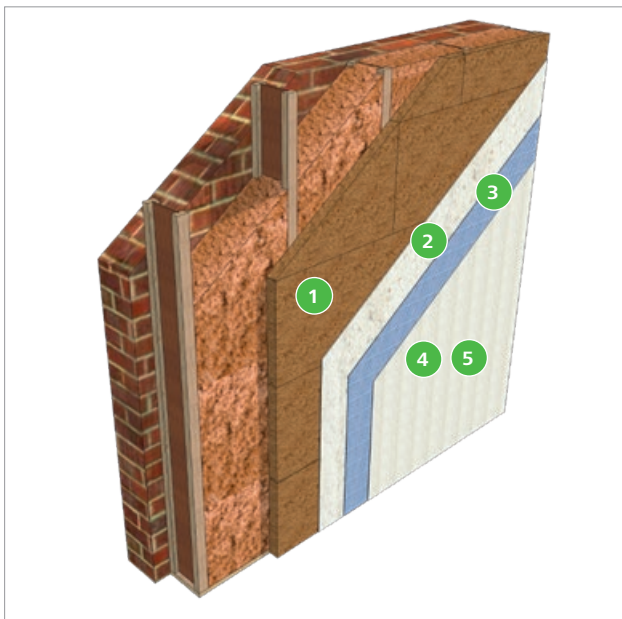

- 1 Wood fibre insulation board**
STEICOprotect/STEICOprotect dry or STEICOduo/STEICOduo dry
Fastening:
Wide back staple or
ejothem STR H screw dowel
- 2 Reinforcing mortar**
Reinforcing fabric
- 3 Intermediate coating (optional)**
Flex slurries (Base area)
Adhesion promoter
- 4 Top coat**
- 5 Finish**

Variant B

Application of an additional compartment level with solid timber, on which the STEICOprotect/STEICOprotect dry / STEICOduo/STEICOduo dry wood fibre insulation boards can be mounted

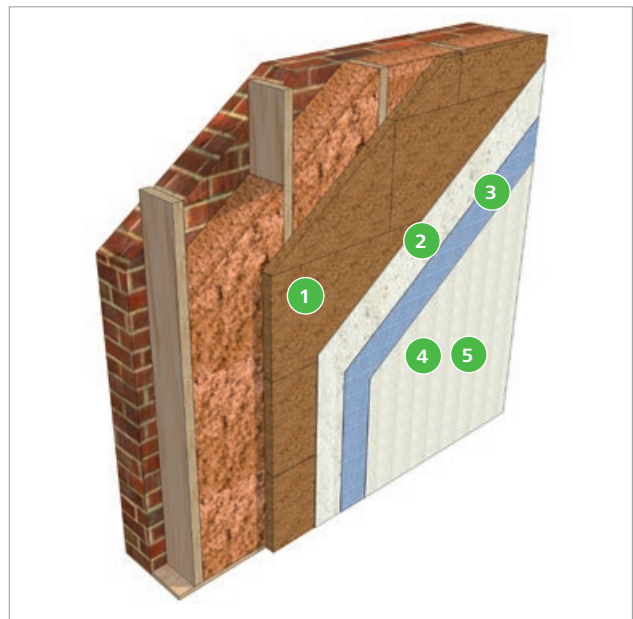

- 1 Wood fibre insulation board**
STEICOprotect/STEICOprotect dry
Fastening:
Wide back staple or
ejothem STR H screw dowel
- 2 Reinforcing mortar**
Reinforcing fabric
- 3 Intermediate coating (optional)**
Flex slurries (Base area)
Adhesion promoter
- 4 Top coat**
- 5 Finish**

Notes for the planner

Buildings and architecture

- Plan sufficiently large roof overhangs (or terraces/balconies) as structural component protection
- Do not select colours which are too dark (light reference value ≥ 20)
- Adjust the choice of render thickness to the local climatic conditions (e.g. driving rain)
- Do not choose a render with a small grain size (recommendation ≥ 2 mm)
- In the case of increased requirements on the execution (dimensional tolerances) this must be agreed with the client as appropriate

- Take into account the nearby plants, in terms of microorganism on the render surface
- Adjust the exterior lighting to the render surface and exclude stray light if necessary

Layer structure

STEICO ETICS systems are classified as normally flammable. Wall constructions with fire resistance classes from REI 30 to REI 90 can be manufactured with STEICO render carrying boards.

Processing

On timber substrates

- For insulation thicknesses up to approx. 140 mm, fastening to the timber frame using staples instead of screw dowels is recommended
- Observe the guidelines for proper use of fastening elements

On existing mineral substrates

- When renovating mineral building materials, a high core moisture of the substrate must be avoided.
- The internal render as the internal airtight layer must be installed and sufficiently dried before the external insulation is applied.

Rendering of wood insulation board

More detailed advice on application with a V-notch trowel can be found on page 28. It can be used to protect the wood fibre insulation board from weathering. Outdoor weathering of up to 5 months is thus possible if the teeth

of the trowel are not completely pressed through and minimal reinforcing mortar remains. The application of the reinforcement layer in two operations is recommended

Handover of trade

If the fixing and rendering of the insulation boards is carried out by two different companies, it is advisable to arrange an appointment with the parties involved (carpenters, renderers, possibly construction management) in order

to transfer the facade from carpenter to renderer. Disagreements can be discussed and assigned to the relevant trades.

For this handover of the trades, checklists can be found in the appendix to these processing instructions (see p. 32).

General processing instructions

The STEICO product range offers outstanding possibilities for the planning of energy-efficient and economical structures for walls. At this point we would like to refer you to our STEICO design booklets, the STEICO detail catalogue and the design details

Storage and transport

The STEICO wood fiber insulation boards are delivered lying on disposable pallets with rain-protected foil packaging. If the foil cover is damaged, additional measures (additional covers) are required. Please keep the packing slips shrink-wrapped in the packaging when opening the packages, as they allow quick access to the internal production data if you have any questions about the delivery.

On delivery, suitable lifting equipment (forklift, crane) should be available on site so that the pallets can be unloaded quickly without damaging the boards. For panel qualities H and M, a maximum of 3 pallets may be stacked on top of each other on a level, dry surface, and a

maximum of 2 pallets for L. The maximum number of pallets that may be stacked on top of each other is 3. The pallets must be aligned flush and stored dry to avoid indentations of the top or bottom panel surface.

When removing or relocating individual boards, make sure that a sufficient number of bearing timbers are available.

The boards must be stored lying flat and dry. Individual boards should be covered during longer storage periods in order to avoid soiling and greying of the board surface due to UV exposure. The boards must be protected from edge damage.

Substrate testing and preparation

Timber substrates

The substrate must be carefully checked immediately before installing the boards. It must be flat/level, clean, dry (wood moisture $\leq 20\%$) and wide enough for fixing.

For timber frame constructions, the maximum permissible spacing of the studs must be checked (see page 15).

Mineral Substrates

The substrate must be dry, dust-free, level, sufficiently load-bearing and free from loose substances. In masonry construction in particular, the interior rendering work should be completed before the thermal insulation composite system is installed so that the exterior walls are not exposed to increased moisture.

Particularly in new buildings, continuous protection against precipitation water must be ensured before installing the thermal insulation. Moisture penetration through the mineral substrate is not permitted. Particularly when renovating old buildings, care must be taken to ensure that rising damp is excluded.

Before installing the insulation boards, all horizontal covers should be installed in order to be able to make an appropriate driving rain-tight connection. Loose layers of render must be removed and any defects must be levelled out. Unevenness of up to approx. 10 mm can be levelled out with an approved mineral adhesive and reinforcing mortar base (applied using the point and bead method). In case of larger unevenness, a levelling render should be applied, which must be completely dry before rendering. Alternatively, the installation of an additional wooden frame construction can also be used.

Board processing

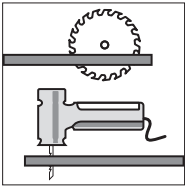

For processing of the STEICO render carrying boards, STEICO offers a cutting table *STEICOisoflex cut combi* a mobile system for cutting and fast processing of insulation materials.

Alternatively, processing with typical woodworking tools is possible (hand-held circular saw, jigsaw, chain saw).

When cutting wood fibre insulation boards, suitable measures must be taken (dust extraction, filter systems). The usual safety regulations for the processing of timber-based materials apply.

Board fixing

General Information

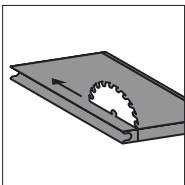

In the case of profiled boards, the groove profiling of the lower longitudinal side of the board must be removed for the first assembly row so that a square board edge is created. Square board edges must also be provided for corner connections.

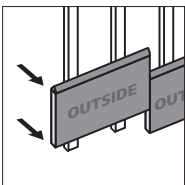

Profiled boards are mounted with the tongue pointing upwards. The stamping on the boards gives the installation side. For waste optimization *STEICOprotect H* / *STEICOprotect M* boards and *STEICOprotect H dry* / *STEICOprotect M dry* boards can be turned. With the *STEICOduo* / *STEICOduo dry* this is also the case.

Joint offset

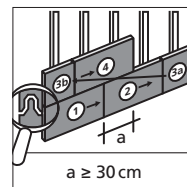

The tongue and groove boards are processed end to end with floating joints horizontally, a minimum offset of 30 cm between vertical joints should be observed. Vertical joints in a compartment directly above each other (cross joints) are not permitted.

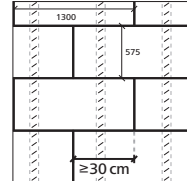

If air-injected insulation is used, vertical joints must be offset so that the nearest joint occurs in the adjacent compartment.

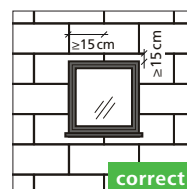

When installing the STEICO wood fiber insulation boards around openings, make sure that the boards are not pushed vertically or horizontally directly into the opening corners, but are offset by at least 15 cm (revolver cut). This counteracts stress concentrations in the insulation board plane (the additional arrangement of the diagonal reinforcement strips in the reinforcement layer must be observed). If there is a board joint in the opening corner, this joint must be glued with *STEICOmulti fill*.



General processing instructions

Board mounting on wall surfaces

The single board must be fixed on at least two studs. If the board is to be fixed to a stud, as in the case of corners, the vertical joint must be glued with *STEICOmulti fill*.

If *STEICOzell* is used as the partition insulation material, the center spacing of the substructure in the edge area can be reduced in order to achieve higher stability.

Board mounting from below

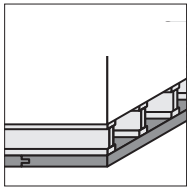

A board assembly from below, which is necessary e.g. for projecting upper storeys, can be carried out with *STEICOprotect H/STEICOprotect H dry*.

STEICOduo/STEICOduo dry boards in 60 mm thickness. The grid dimension of 41.7 cm must not be exceeded. The number of fasteners increases by 1/3.

Corner formation

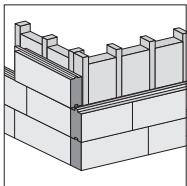

In timber construction, STEICO render carrying boards do not have to be interlocked in the corner area.

When gluing square edge formats on mineral substrates, corner tothing is necessary. Bonding of the square joints and bearing joints is not necessary.

An attachment to a stud located in a corner is sufficient. If this is not the case, the vertical joint must be glued using *STEICOmulti fill* between the front side and the back of the corner boards.

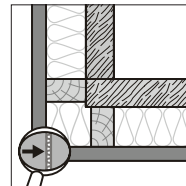

STEICOmulti fill is applied as a bead (diameter approx. 8 mm) in wave form to the front side of the already mounted board.

Thickness [mm] STEICO Wood fiber insulation boards	Maximum overhang [mm] For glued STEICO render base board external corners
40	160
≥ 60	200

Joint formations

Open joints in board joints in the facade surface

Joints between boards with a width of 2 - 5 mm must be filled with *STEICOmulti fill* 2 cm deep or up to the tongue. Joints in the façade with a width >5 mm must be filled with fitting pieces, glued with *STEICOmulti fill* and then sanded. This allows vertical forces to be transferred and thus prevents marks in the render.

Floor joint

The floor joint in timber frame construction must be tension and compression resistant as well as settling proof and thermal bridge minimized. Compressive forces must be absorbed by the load-bearing timber structure. Force transmission in the ETICS can lead to creases.

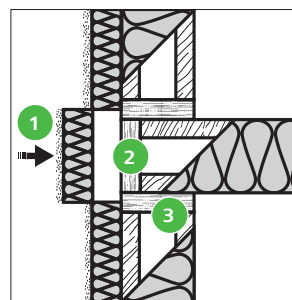

To prevent settlement due to shrinkage, use *STEICO LVL X* (Laminated Veneer Lumber) as the rimboard in the intermediate area. Fitting pieces for floor joints must be glued in using *STEICOmulti fill* in order to be able to rule out buckling of the render at a later date.

- 1 Glue in 1 fitting piece with *STEICOmulti fill*, then sand the square joint
- 2 *STEICO LVL X*
- 3 Tensile and compression-proof connection
See construction detail p. 64

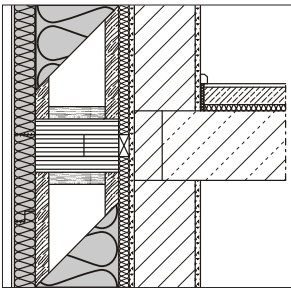

If, due to inaccuracies during processing, board joints may still occur, these joints must first be backed with a dimensionally stable and pressure-resistant wood-based material. The last 20 mm of the joint must be filled with *STEICOmultipfill* and then sanded.

Expansion joints in component connections

They occur when connections to other components are made e.g. roof boards or extensions. It is also a movement joint between the perimeter insulation of the basement and the timber construction of the ground floor.

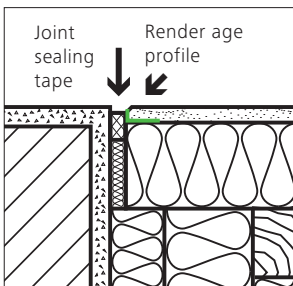

These joints are made with a STEICO Joint Sealing Tape and a STEICO Render Finishing Profile.

Building expansion joints

Expansion joints in buildings must be considered in the ETIC system at the same location and must not be rendered

Air-injected insulation

Even with air-injected insulating materials such as *STEICOzell*/*STEICOflor*, it is necessary to attach the individual STEICO render baseboard to at least two studs. The vertical joints must be offset by compartments. In the corner area, the grid dimension of the substructure can be reduced if necessary in order to achieve greater stability. Cross joints are not permitted.

If a air-injected insulating material is injected into the compartment behind the *STEICOprotect*/*STEICOprotect dry*, it must be injected completely,

over. Vertical expansion joints must also be provided for building lengths of >20 m. The expansion joints must be installed in the same place in the ETIC system.

Additional storeys

When building additional storeys differential movement can occur between the solid structure and the timber construction, which can lead to cracks in the render layer. Therefore, this connection is usually carried out with an overhang of the timber construction and incorporates a drip bead.

If a continuous render layer is required, the following procedure should be followed:

The timber construction of the extension (outer edge of the timber frame work) must be flush with the solid structure. Construction timber of at least 6 * 6 cm is screwed onto the studs of the timber frame construction, which protrude into the solid construction and are connected with it. The joints of the 6 * 6 cm squared timber must be offset in height.

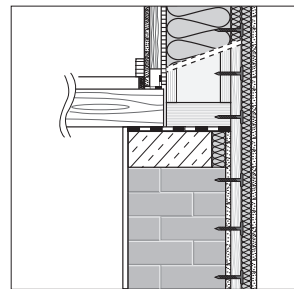

Subsequently, the compartment that was created on the entire facade is insulated with *STEICOflex*. This substructure is then used to fasten *STEICOprotect H* or *STEICOprotect H dry* panels, which are then rendered.

securely and void-free before the render coating of the *STEICOprotect*/*STEICOprotect dry* panels.

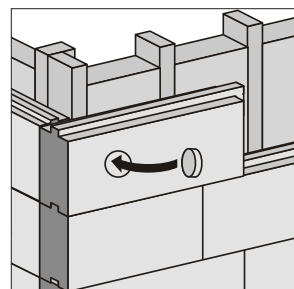

Air-injected openings can be closed with *STEICOmultipfill* and STEICO wood fibre stoppers.

It is absolutely necessary to sand the closures before applying the render.

General processing instructions

Mounting light loads



Light loads such as exterior lamps or letterboxes can be fastened to the STEICO*protect*/STEICO*protect dry* board with insulating material dowels such as the STEICO mounting spiral. The hole for the mounting spiral should be predrilled with an 8 mm diameter wood drill bit.

With this process, care must be taken to prevent moisture from penetrating (driving rain). If possible, a joint sealing tape should be used when penetrating and the connection should be sealed with a permanently elastic, reworkable joint sealant.

Larger loads, such as awnings, must be taken into account at the planning stage. For this purpose, a load-bearing substrate must be created below the ETICS (e.g. STEICO *LVL* veneer laminated wood) in order to be able to safely transfer loads to the wall structure using suitable fastening systems.

This substructure must be insulated with at least 60 mm STEICO*protect H*/STEICO*protect H dry*.

(Product information see page 8)

Outdoor exposure

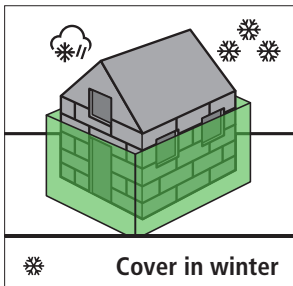

The finished wall surface can be exposed to normal weathering (predominantly dry periods with light/short rain) for four weeks until the render coating is applied.

Both horizontal and vertical edges which are directly exposed to weathering (eg around windows) must be suitably protected from exposure.

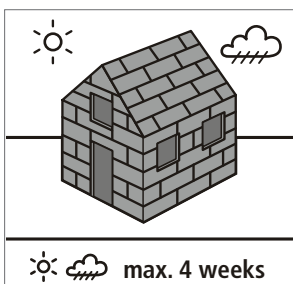

In principle, the construction site can be overwintered when a tooth applied render is applied. If the teeth of the notched trowel are not completely pressed

through, minimal reinforcing mortar remains in the recesses. When combed vertically, the rainwater can flow off unhindered. Outdoor weathering of up to five months is thus possible.

By planning off (temporary counter battens, working scaffolding, use of a roof overhang) a longer outdoor weathering can be achieved, especially with unexpectedly early winter periods.

In this case, all surfaces must be carefully checked before applying render and any joints or thickness offsets must be corrected. Temporary drains from unfinished roof guttering must keep the water safely away from the wall surface.

Base areas on exposed sides – ideally the complete facade surface – should be protected from moisture penetration and dirt caused by high spraying dirt (e.g. tarpaulins on the working scaffold). It must be possible to drain rainwater quickly and safely away before it reaches the facade surface; under no circumstances must the wall cross-section be in permanent contact with moisture or moist soil masses. In the case of surfaces that have been exposed to the weather for longer periods of time, a visual inspection of the surface must be carried out before the render is applied. Corresponding reworking by sanding is necessary. The resulting dust must be removed by sweeping or vacuuming. Blowing with oil-free compressed air is also possible.

(Limit humidity: see page 13)

Areas of application

Timber substrates or mineral substrates in existing buildings

STEICOprotect from the wet process

Produkt	STEICOprotect H ¹⁾		STEICOprotect M		
Range of application	Timber studs with or without board material		Timber studs with or without board material		
Thickness [mm]	40, 60	40, 60	80, 100	80	80, 100
Format [mm]	1325 * 600 2625 * 1175	2800 * 1250	1325 * 600	2625 * 1175	2800 * 1250
Cover dimension [mm]	1300 * 575 2600 * 1150	–	1300 * 575	2600 * 1150	–
Max. stand axis dimension [mm]	≤ 625	≤ 625	≤ 625	≤ 835	≤ 625
Edge formation	T & G	Square	T & G	T & G	Square

STEICOprotect dry from the dry process

Produkt	STEICOprotect H dry ¹⁾		STEICOprotect M dry		STEICOprotect L dry
Range of application	Timber studs with or without board material		Timber studs with or without board material		Mineral substrate
Thickness [mm]	40, 60	40, 60	60 - 200	60 - 160	100 - 240
Format [mm]	1325 * 600	2800 * 1250	1325 * 600	2800 * 1250	600 * 400 1200 * 400
Cover dimension [mm]	1300 * 575	–	1300 * 575	–	–
Max. stand axis dimension [mm]	≤ 625	≤ 625	≤ 625 ²⁾	≤ 625 ²⁾	–
Edge formation	T & G	Square	T & G	Square	Square

STEICOduo from the wet process

Produkt	STEICOduo
Range of application	Timber studs with or without board material
Thickness [mm]	40, 60
Format [mm]	1.880 * 600
Cover dimension [mm]	1.855 * 575
Max. stand axis dimension [mm]	≤ 625
Edge formation	T & G

STEICOduo dry from the dry process

Produkt	STEICOduo dry	
Range of application	Timber studs with or without board material / CLT or LVL	
Thickness [mm]	40, 60	
Format [mm]	1.880 * 600	3.000 * 2.500 6.000 * 2.500
Cover dimension [mm]	1.855 * 575	–
Max. stand axis dimension [mm]	≤ 625	≤ 625
Edge formation	T & G	Square

1) As a square reveal board 20mm thick, format 1350 * 500mm

2) ≤835, when the insulation board is min. 80mm thick

Wood fibre insulation board on timber substrate

Fastening methods

STEICO*protect*/STEICO*protect dry* boards can be anchored in the timber substrate with stainless steel wide back staples or ejothem STR H screw anchors.

Wide-backed staple

With 60 mm board thickness e.g. acc. to AbZ. 27*100*1,8 mm

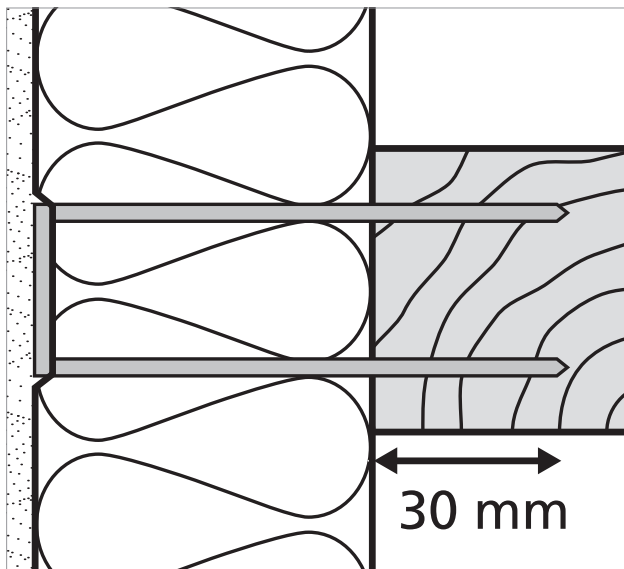

- Approved stainless steel wide back staple according to Eurocode 5
- Insertion of the staples close to the surface if possible, i.e. max. 2 mm deep and inclined at 30°
- Anchoring depth in the load-bearing timber substrate min. 30 mm¹⁾

ejothem STR H Screw anchor

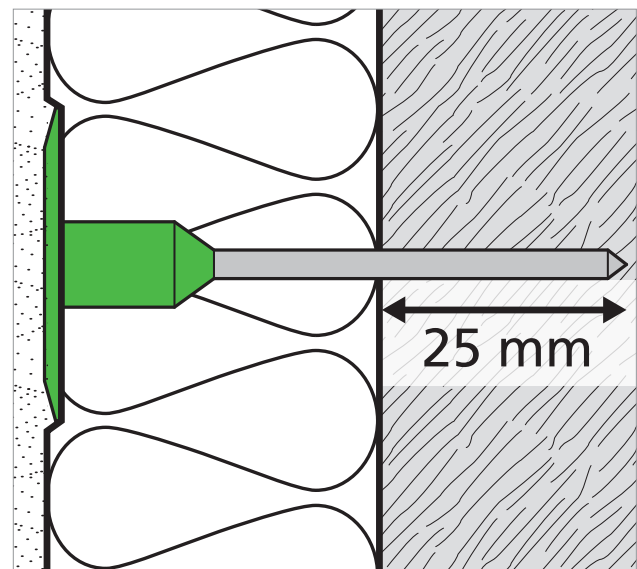

- Metal screw with plastic plate
- Torx drive TX 25
- Thermal decoupling of the screw by means of ejothem STR insulation plugs, which must be inserted flush with the surface of the anchor. (Insulating plug is included in accessories)
- Place the screw plug on the outside with the upper edge of the plug flush with the wall surface.
- Anchoring depth in the load-bearing timber substrate in accordance with applicable regulations min. 25 mm²⁾
- In the event that screw anchors have been driven in too deeply or screwed in, they must be filled flush with the surface before the reinforcing render is combed.

For cellular concrete and other substrates please refer to the EJOT data sheets.

1) Staples must always be placed on the board surface. It is not permitted to place the staples on the panel joint, especially in the case of tongue and groove panels.

2) The screw-in depth of the ejothem STR H screw-anchor is offered in the 40 mm range in order to ensure flush-surface driving of all panel types.

Fixing

The minimum number of fixings according to the approval for the respective wind load must be observed. The characteristic wind suction w_{ek} and an aerodynamic pressure coefficient z_e and an aerodynamic pressure coefficient c_{pe} . (See Eurocode 1 Effect on Structures – Wind Loads)

Minimum number of fixings per m² and max. permissible vertical distance between fasteners for timber frame constructions with or without board materials (stud spacing 62.5 cm to 83.5 cm⁵⁾) and for solid wood substrates.

Minimum fixings/m ²	Characteristic effects of Wind w_e bis [kN/m ²]			Allowed vertical distance between fixings [mm]
	-0,55	-1,00	-1,60	
ejotherm STR H Screw anchors				
STEICO <i>protect M</i> ¹⁾	4	6	6	–
STEICO <i>protect H</i> ¹⁾	4	6	6	–
STEICO <i>duo</i>	4	6	6	–
STEICO <i>protect L dry</i>	5	6	8	–
STEICO <i>protect M dry</i>	4	6	6	–
STEICO <i>protect H dry</i>	4	6	6	–
STEICO <i>duo dry</i>	4	6	6	–
Staples				
STEICO <i>protect M</i>	17	17	25	90
STEICO <i>protect H</i>	12	12	16	150
STEICO <i>duo</i>	12	12	16	150
STEICO <i>protect L dry</i> ²⁾	18	25	34	70
STEICO <i>protect L dry</i> ³⁾	25	38	55	70
STEICO <i>protect M dry</i> ²⁾	10	15	20	90
STEICO <i>protect M dry</i> ³⁾	15	22	33	90
STEICO <i>protect H dry</i> ²⁾	6	8	10	150
STEICO <i>protect H dry</i> ³⁾	7	10	14	150
STEICO <i>duo dry</i> ²⁾	6	8	10	150
STEICO <i>duo dry</i> ³⁾	7	10	14	150
Wide back staples BEA 346"⁴⁾				
STEICO <i>protect M dry</i>	10	14 ⁵⁾	14	150
STEICO <i>protect L dry</i>	10	14 ⁵⁾	14	150

1) With a stud spacing of 83.5 cm, the insulation board must be at least 80 mm thick.

2) Staples must always be placed on the board surface. It is not permitted to place the clamps on the panel joint, especially in the case of tongue and groove panels.

3) In the case of square board joints, a central, single-row staple fastening is possible, taking into account the required edge distances.

4) Only to be used with insulation thickness ≤ 160 mm

5) Only possible with stud spacings of 62.5 cm, equates to staple spacing of 125 mm. With stud spacings of 83.5 cm the characteristic effects of wind up to -1.60 kN/m² can only be realised with staples if all the staples are set into the board surface. In these situations 10 staples /m² with a vertical distance of 125 mm is sufficient.

Wood fibre insulation board on timber substrate

Fixing directly on timber studs or on panels/coverings made of board materials

In both cases, the insulation boards must be fastened directly to the studs, i.e. in the case of boarding/cladding, the anchoring must be made through the board material into the timber studs. The maximum permissible vertical distances of the fasteners must be observed. An even distribution of the fasteners over the height of the storey should also be strived for. For stud spacings up to 83.5 cm, the required thickness of the insulation board is at least 80 mm.

Fixed directly to timber studs



Timber frame with no external board material

Fixed directly on panels/coverings made of board materials

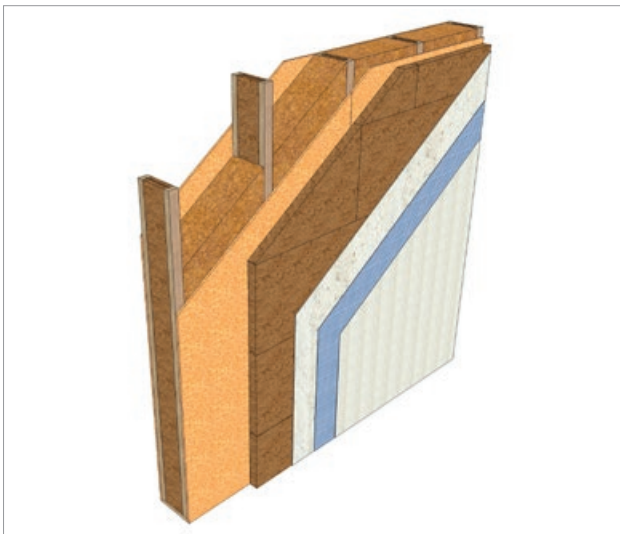

Timber frame with external board material

Fixing with ejothem STR H screw anchor

Center spacing of the timber stud 62.5 cm

	STEICOprotect H/M, STEICOprotect H/M dry, STEICOduo/STEICOduo dry
Wind pressure w_e [kN/m ²]	up to -1,60
Number [pieces/m ²]	≥ 6
Max. fastener spacing [mm]	250
Edge distance [mm]	≥ 50

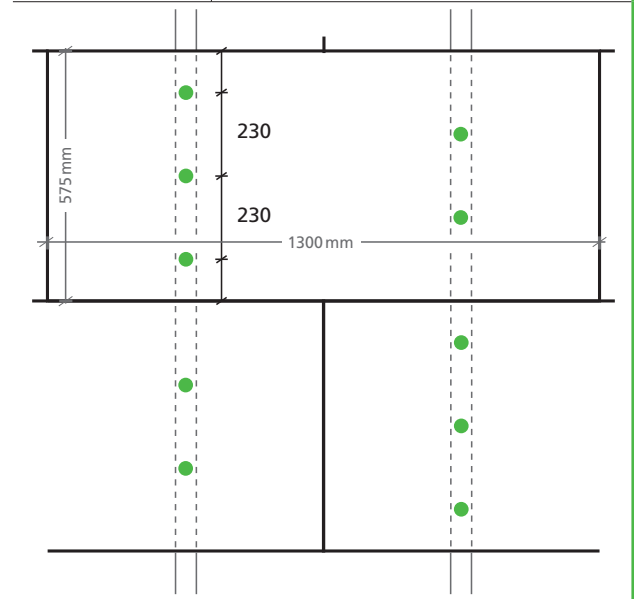

Fastening with stainless steel broad back staples

Center spacing of the timber stud 62.5 cm

	STEICOprotect H, STEICOduo	STEICOprotect H dry, STEICOduo dry
Wind pressure w_e [kN/m ²]	up to -1,00	up to -1,60
Number [pieces/m ²]	≥ 12	≥ 10
Max. staple spacing [mm]	150	
Edge distance [mm]	20 - 50	

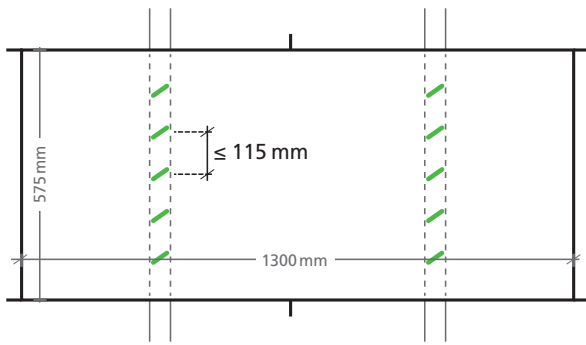

	STEICOprotect H, STEICOduo
Wind pressure w_e [kN/m ²]	up to -1,60
Number [pieces/m ²]	≥ 16
Max. staple spacing [mm]	150
Edge distance [mm]	20 - 50

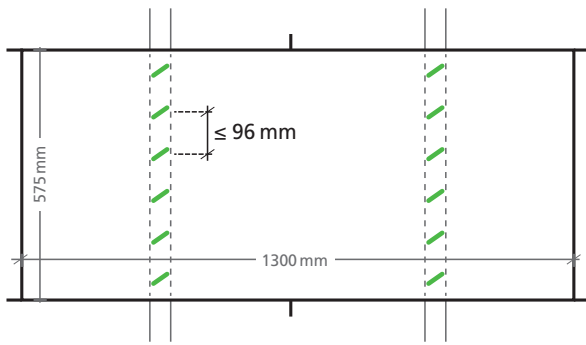

	STEICOprotect M, STEICOprotect M dry
Wind pressure w_e [kN/m ²]	up to -1,00
Number [pieces/m ²]	≥ 17
Max. staple spacing [mm]	90
Edge distance [mm]	20 - 50

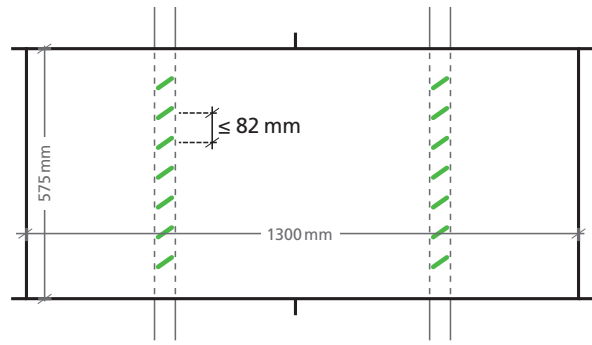

	STEICOprotect M, STEICOprotect M dry
Wind pressure w_e [kN/m ²]	up to -1,60
Number [pieces/m ²]	≥ 25
Max. staple spacing [mm]	90
Edge distance [mm]	20 - 50

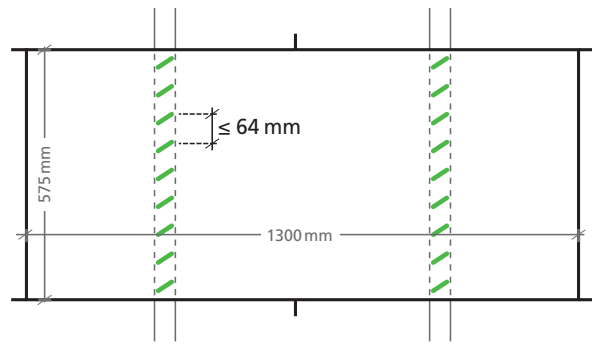

Wood fibre insulation board on timber substrate

Fixing on solid timber substrates – CLT/LVL

A uniform pattern of the fixings means, the maximum permissible vertical distance and sufficient fixing of at least the vertical board edges must be ensured.

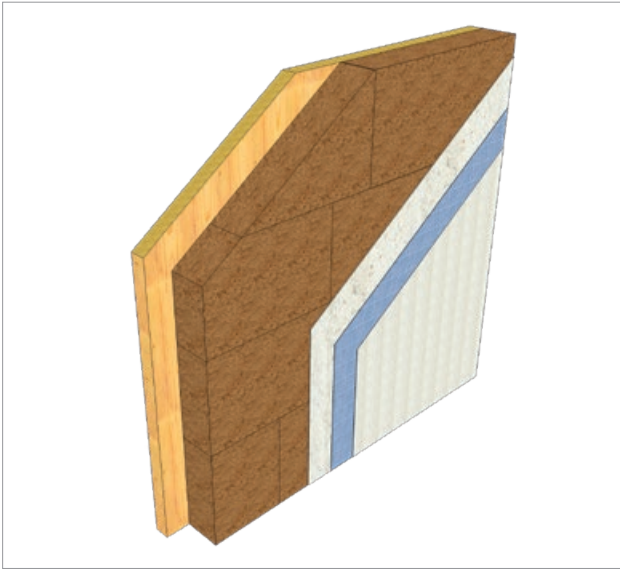

Fixing with stainless steel wide back staples

	STEICOprotect L dry
Wind pressure w_e [kN/m ²]	up to -1,60
Number [pieces/m ²]	≥ 34
Max. staple spacing [mm]	70
Edge distance [mm]	20-50

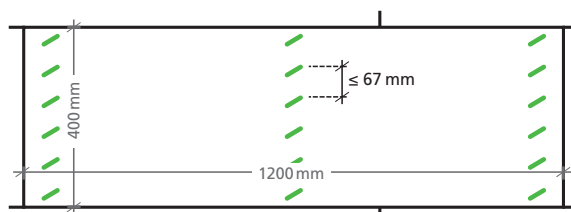

Fixing with ejothem STR H screw anchor

STEICOprotect L dry	
Wind pressure w_e [kN/m ²]	up to -1,00
Number [pieces/m ²]	6,3

STEICOprotect H, STEICOprotect H dry, STEICOprotect M, STEICOprotect M dry	
Wind pressure w_e [kN/m ²]	up to -1,60
Number [pieces/m ²]	≥ 6

STEICOprotect L dry	
Wind pressure w_e [kN/m ²]	up to -1,60
Number [pieces/m ²]	8,3

STEICOprotect L dry	
Wind pressure w_e [kN/m ²]	up to -1,60
Number [pieces/m ²]	8,3

Wood fibre insulation board on timber substrate

Processing on the windowsill with STEICOfix

This sensitive component connection must be carried out with the greatest possible care and suitable materials. Since several trades (assembly of the panels, rendering company, window manufacturer, possibly sun protection specialist) are involved in this connection, careful planning involving all trades involved is essential in order to guarantee permanent safety.

The wood fibre insulation wedge STEICOfix acts as a second water-bearing layer and prevents unforeseen moisture penetration in the windowsill area from damaging the ETICS and the layers behind it. The solution is optimum because familiar and easy-to-process materials are used.

Note: To ensure the correct sizing of the STEICOfix insulation wedge and windowsill correct planning of the window depth / reveal should be undertaken. A vertical section through this area will help to correctly detail this area.



Attachment of STEICOmulti UDB (diffusion-open membrane) as temporary weather protection until window installation.



The windows are installed on the membrane. Before STEICOfix is installed, the sheet is cut back „half-moon-shaped“ (see Fig. 5).



The STEICOmulti tape F adhesive strips are then attached to the insulation wedge in such a way that a three-sided „trough“ is formed.

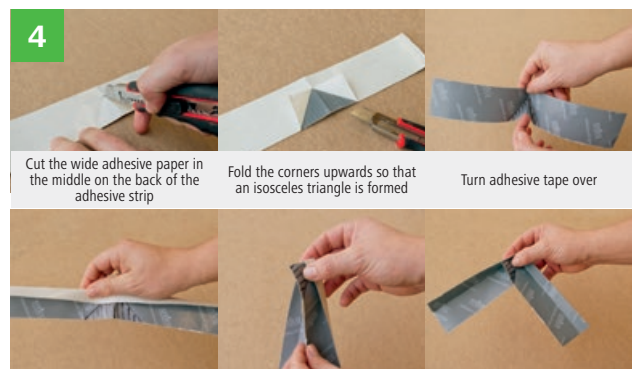

Cut the wide adhesive paper in the middle on the back of the adhesive strip

Fold the corners upwards so that an isosceles triangle is formed

Turn adhesive tape over

To form the corners, the adhesive strips are cut to double the width of the insulation wedge. Then follow the steps described above.



STEICOmulti fill adhesive beads are used to secure the insulation wedge against lifting off, $e \leq 30$ cm.



6

Installation of the STEICO*fix* insulation wedge. **TIP:** Fold back release paper, it can be removed more easily later.



9

The protruding flap of the laminated underlay is glued to the drip edge of the parapet profile using STEICO*multi fill*.



7

Insert the STEICO*fix* insulation wedge into the reveal, remove the remaining adhesive tape liner and press on the STEICO*multi tape F* adhesive tape.



10

Application of STEICO*multi fill* adhesive beads $e \leq 30$ cm for the elastic fixing of the windowsill. **TIP:** Compriband strips glued at an angle guide any moisture that may enter safely to the drip edge.



8

For a secure render connection, an attic profile is installed below the STEICO*fix* wood fibre insulation wedge (stainless steel screws or clamps in the wood fibre insulation board).



11

Installation of windowsill. **TIP:** The rear sheet metal interlocking is located in the matching window groove, the front one has a distance of ≥ 3 cm to the render facade **TIP:** Storing Compriband strips in the cool box prevents them from expanding too quickly.

Wood fibre insulation board on timber substrate



12

Installation of the reveal board. Protection against driving rain by applying joint sealing tapes to the front and end edges.



15

Fixation of the reveal board for undisturbed hardening of STEICO*multi fill* by means of wide back clamps or stainless steel screws.



13

Application of STEICO*multi fill* adhesive beads into the timber frame construction to ensure a secure hold of the reveal board.



16

Ready!
Quick and easy.

Application of the appropriate stop bead for a secure render connection and subsequent continuation of the ETIC system.



14

Inserting the reveal board flush with the outer edge of the ETICS facade **TIPP:** If necessary, plan for window frame widening.



STEICO Tube

The STEICO*fix* manual is also available as a video.

Roller shutters/external blinds

Free roller shutter/external blind box

The STEICO wood fiber insulation board is backed with a wood material board to which the thermal insulation composite system is attached. The thickness of STEICO*protect* / STEICO*protect dry* is the same for wood-based boards. To reduce the thickness of the wood-based board, the insulation of the box should be at least 40 mm.

The fastening consists of a glued joint. (STEICO*multi fill* see following sketch) and mechanical fixing with EJO THERM STR H screw dowels or wide back staples. The junction must be sanded. If the fasteners stand through the wood-based board, they are then cut back. In the case of very wide-span window hinges, the lower edge of the wood-based board can be reinforced by a metal angle or rail.

Integrated roller shutter/external blind box

If the box is permanently installed, STEICO wood fiber insulation boards can be attached directly to the box. This fastening is carried out with STEICO*multi fill*.

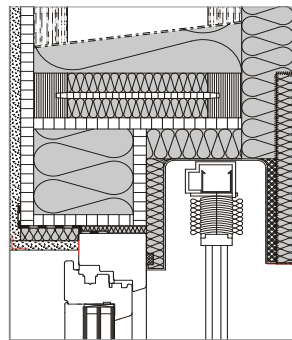

See construction detail
page 24

If the box protrudes into the ETICS insulation level, the cover plate of the box (at least 40 mm thick) is selected to be 10 cm larger on all sides than the box and a corresponding step seam is produced for the insulation boards in the facade surface. For wet boards this can be done by sawing in and removing the first 2 insulation layers, for dry boards by routing out accordingly.

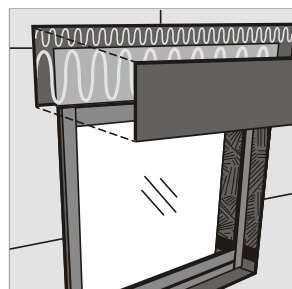

The cover plate (at least 40 mm thick) is then glued with STEICO*multi fill* with the actual ETICS and the roller shutter/blind box. A mechanical fixing with EJO THERM STR H screw anchors or wide back staples must then be carried out. The junctions must be sanded.

For more information, please visit:

www.dundm.com or www.guenthner.de

Wood fibre insulation board on timber substrate

DPC Level

Splash-water-endangered areas

The first 30 cm above the ground at base connections are known to be the splash water area. In addition to this, wall surfaces in the connection area of terraces, flat roofs, canopies and dormer walls are also endangered by splash water. In these areas, moisture-resistant base insulation boards are to be used, which are available in the range of the respective render manufacturer. These must be backed by moisture-resistant material boards (cement-bonded boards such as Fermacell Powerpanel HD or Knauf Aquapanel).

In the case of splash water-reducing substrates, such as a gravel strip (grain size 16/32, width 30 cm) or permeable terrace cladding (rust), the height of the splash water area can be reduced to 150 mm. Direct laying of dense building materials such as paving stones on STEICO wood fiber insulation boards is not permitted. Self-adhesive bitumen membranes (e.g. Dörken Delta-Thene or PCI Pecithene) have proved their worth as waterproofing in the base area).

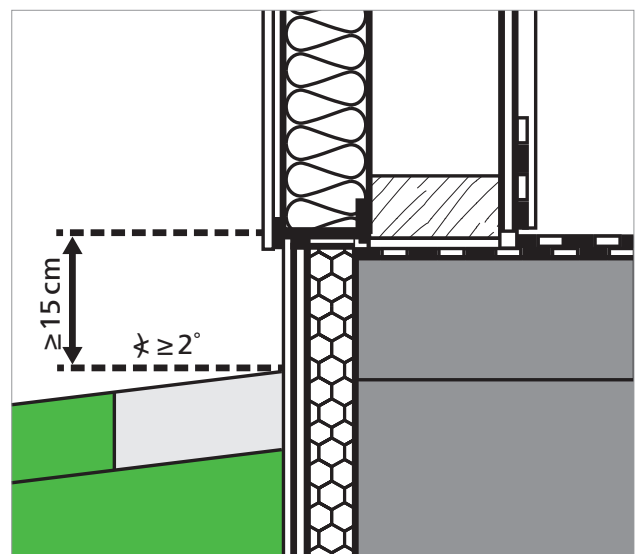
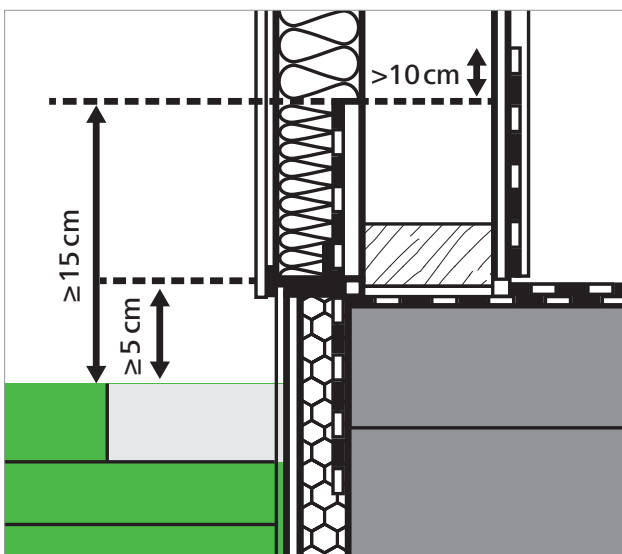
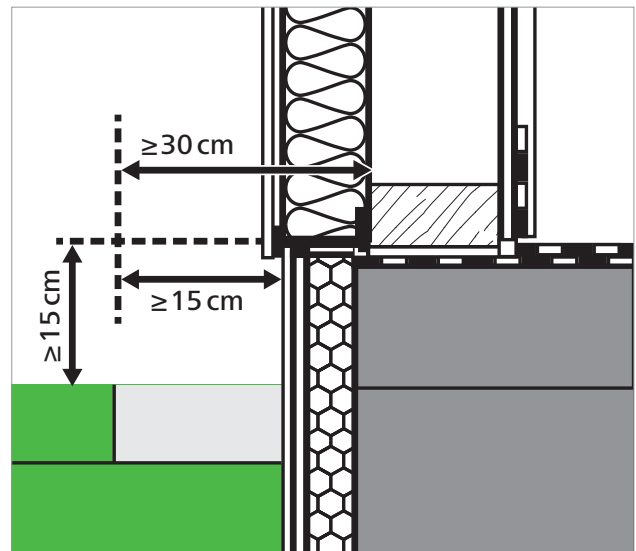
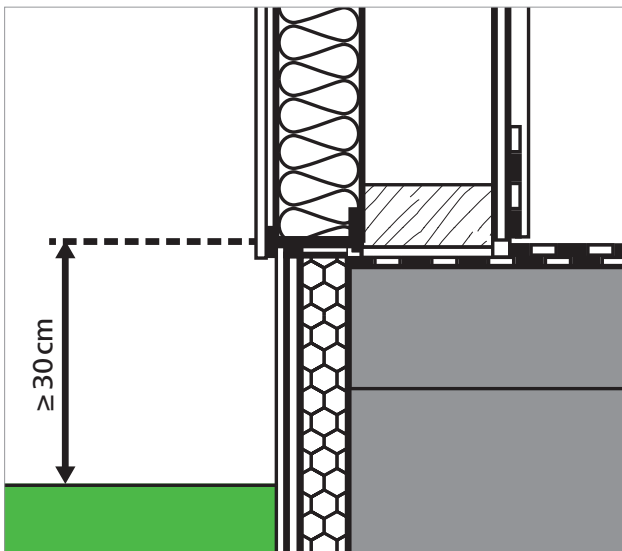

See also the detail catalogue on page 25

Wood fibre insulation board on masonry

Installation

Fixing of the wood fiber insulation boards in the base area

If no perimeter insulation is in place, the first board layer can be placed on a temporary lath or squared timber anchored to the mineral substrate. After the lath has been removed, a base profile can be fixed to the bottom of the wood fiber insulation board with STEICO*multi fill* or a double-sided adhesive tape, and the perimeter insulation board can then be connected with an appropriate tape.



Attach angle rail

Alternatively, the first layer of the wood fiber insulation boards can also be placed on an angled rail, which is fastened to the mineral substrate with impact dowels. The rest of the procedure is as described above.

If no perimeter insulation is provided in the base area, a thin plastic or sheet metal profile may have to be glued on as a back cover, depending on the panel thickness.

If a horizontally aligned and flat perimeter insulation is already in place, the first layer of the wood fiber insulation boards can be placed on it. Before the render baseboard is placed on the perimeter insulation board, a corresponding compri-band must be glued onto it. The base profile must then be placed on this.

Bonding of the render carrying boards

The STEICO*protect L dry* render carrying boards must be bonded to the substrate with an approved mineral base adhesive and reinforcing mortar and additionally fastened with ejothem STR U 2G screw anchors.

Full-surface bonding (recommendation)



Glue the insulation board to a flat surface with full-surface bonding

The base mortar is first applied to the entire surface as a thin layer to the back of the wood fiber insulation board using a notched trowel and massaged in to improve adhesion. Immediately afterwards, the final quantity of adhesive required is applied wet-on-wet with a 15 * 15 mm trowel and the entire surface is toothed off. The boards are then pressed against the wall. In this way, irregularities in the substrate of up to 3 mm can be levelled out. ¹⁾

The boards are then pressed against the wall. In this way, irregularities in the substrate of up to 3 mm can be levelled out. ¹⁾

Bonding using the dot and bead method



Adhesion of insulation boards on uneven surfaces using the point and bead method

The base adhesive and reinforcing mortar is first applied to the entire surface as a thin layer to the back of the render carrying board using a notched trowel and massaged in to improve adhesion. Immediately afterwards, both adhesive dots and a circumferential adhesive edge are applied in the required

amount of adhesive wet-on-wet using the so-called dot-bead process. The amount of adhesive should be at least 40 % The boards are then flattened, pressed tight together and pressed against the wall. In this way, unevenness in the substrate of up to 10 mm can be levelled out. ²⁾

1) Boards should be 'wiggled' in. They must not be knocked, or the render will loose contact with the board. In this way fully bonding the boards, irregularities of up to 3mm can be levelled out.

2) Boards should be 'wiggled' in. They must not be knocked, or the render will loose contact with the board. In this way fully bonding the boards, irregularities of up to 10mm can be levelled out.

Wood fibre insulation board on masonry

Installation of the render carrying boards



Installation of small-format square edge boards

The small format, square edge boards (thickness between 80-200 mm) are to be laid horizontally and precisely. When gluing square edge board formats on mineral substrates, the corners must interlock.

For a sufficient contact pressure of the render carrying board to the substrate

(light tapping with a rubber hammer and fixing with a screw dowel ejothem STR U2G, if necessary with two

screw anchors).

No adhesive mortar must get into the joints of the render carrying boards. Any excess adhesive mortar that swells out must be removed.

Rear ventilation of the render baseboards or moisture ingress into the ETICS by convection must be prevented. For this purpose, a joint sealing tape 15/5-12 mm can be installed behind the first row of insulation boards.

In ETICS on mineral substrates, a second water-bearing level in the form of a STEICO*fix* insulating wedge must also be installed under the window sills. For a better adhesion of the adhesive tape STEICO*multi tape F* 20/40 mm, the render carrying boards in the reveal can be primed with STEICO*multi fill*.

Fixing



In addition to bonding with a mineral adhesive and reinforcing mortar, the render baseboards must also be fastened with ejothem STR U 2G screw anchors. The corresponding anchor pattern results from the respective wind load.

Anchoring must only be carried out once the base adhesive and reinforcing mortar has set completely. The fixing of the anchors in the substrate must be carried out in accordance with the building supervisory approval of the anchor manufacturer.

The ejothem STR U 2G screw anchors (see dowel pattern on following page) must be placed flush with the wall surface on the outside with the upper edge of the dowel. In the event that screw anchors have been hammered in too

deeply or screwed in, they must be levelled off before the reinforcing render is applied.

Finally, the screw openings of the screw plug ejothem STR U 2G are closed with the special ejothem STR insulating plug. This must be inserted flush with the surface in the anchor. (Order insulation plug as additional item)

Drilling

For pre-drilling of the wood fibre board and also drilling into the mineral substrate the following drill-bits are recommended

- ALPEN HM Universalboher Profi Multicut
- Bosch CYL MultiConstruction

Fixing with screw dowel ejothem STR U 2G

Minimum number of anchors/m² according to approval

Insulation thickness [mm]	Anchor load class [kN/anchor]	Wind pressure w_e (wind suction loads) according to DIN 1055-4 [kN/m ²]		
		-0,55	-1,00	-1,60
≥ 100	≥ 0,15	5	8	13

STEICOprotect L dry

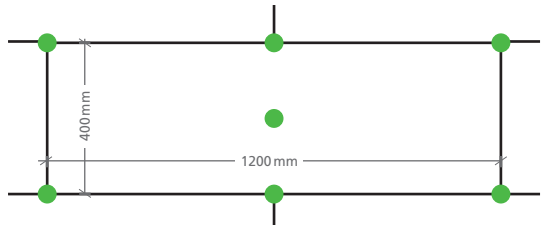
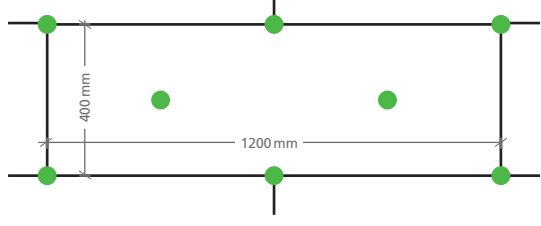
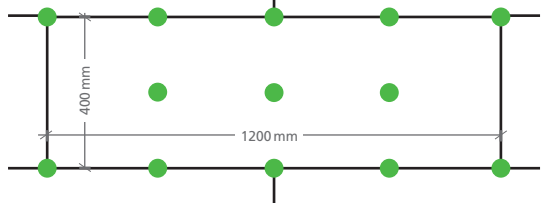
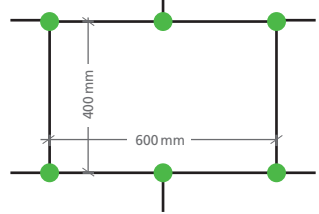
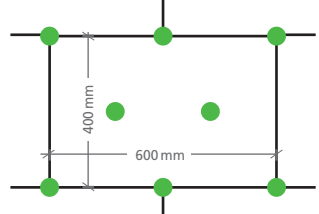
Board size [mm]	Board thickness [mm]	Wind pressure w_e [kN/m ²]	Number [pieces/m ²]	
1200 * 400	100 - 200	up to -0,55	6,3	
		up to -1,00	8,3	
		up to -1,60	14,58	
600 * 400	100 - 200	up to -1,00	8,3	
		up to -1,66	16,7	

Processing render components

General

After completion of the ETICS system, the confirmation of the installation companies that the ETICS has been properly executed must be handed over to the client.

Inspection of the substrate prior to the rendering work



Material moisture

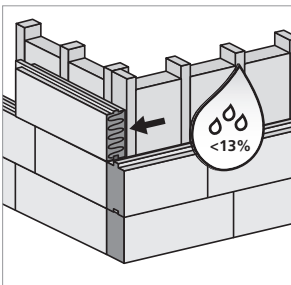

Wood fibre insulation boards are delivered dry. On building sites, a moisture of the material is created, which allows an immediate render coating. In the case of prolonged damp weathering with driving rain, or also in periods of time with very high

humidity, the moisture content of the un-rendered wood fibre boards can increase significantly. Before rendering, the moisture content of the wood fibre insulation board must be 13%.

This ensures that there is no brown staining and to achieve dimensional stability. The check can be carried out with the GANN Hydromette BL H41 electronic moisture meter for wood. In the absence of a suitable measuring instrument, a PE foil test can help to provide guidance. A PE foil area of approx. 70 * 70 cm is used for this test – airtight with an adhesive tape on the STEICO render carrying board. If condensation forms after approx. 24 hours, do not apply a coating.

The moisture content of timber building components should not be greater than the value permissible based on their intended future use.

Board surface

After fixing the STEICO render carrying boards, the finished surface must be checked for defects, panel joints and unevenness and repaired accordingly. Height offsets in the wood fiber insulation boards can be reworked with a sanding board or an orbital sander. Any dust created must be completely removed from the surface.

System components product overview

Wood fibre insulation boards

STEICOprotect

Wood fibre insulation board for ETICS

Production process	wet process
Bulk density [kg/m ³] (approx.)	type H: 265, type M: 230
Nominal value thermal conductivity λ_D	type H: 0,048, type M: 0,046
Certification	<ul style="list-style-type: none"> According to DIN EN 13171 render-coatable wood fibre insulation board for exterior walls in wood construction
Installation areas	Render coatable wood fibre insulation system



STEICOprotect dry

Wood fibre insulation board for ETICS

Production process	dry process
Bulk density [kg/m ³] (approx.)	type H: 180, type M: 140, type L: 110
Nominal value thermal conductivity λ_D	type H: 0,043, type M: 0,040, type L: 0,037
Certification	<ul style="list-style-type: none"> According to DIN EN 13171 render-coatable wood fibre insulation board for exterior walls in wood construction
Installation areas	Render coatable wood fibre insulation system



STEICOduo

Combined insulated sheathing and render board

Production process	wet process
Bulk density [kg/m ³] (approx.)	265
Nominal value thermal conductivity λ_D	0,048
Certification	<ul style="list-style-type: none"> Wood fibre insulation board for exterior walls in wood construction with tongue and groove, coatable with render according to DIN EN 13171 Heat-insulating sub-cover panels Wall construction panel behind curtain-type facades
Installation areas	Render coatable wood fibre insulation system Roof construction insulated sarking under roof covering Wall construction insulation behind a rain screen



STEICOduo dry

Combined insulated sheathing and render board

Production process	dry process
Bulk density [kg/m ³] (approx.)	180
Nominal value thermal conductivity λ_D	0,043
Certification	<ul style="list-style-type: none"> According to DIN EN 13171 render-coatable wood fibre insulation board for exterior walls in wood construction with tongue and groove
Installation areas	Render coatable wood fibre insulation system Roof construction insulated sarking under roof covering Wall construction insulation behind a rain screen



System components product overview

Fixings for STEICOprotect for Timber constructions

ejothem STR H screw anchor

Screw anchor Wood screw for STEICO ETICS incl. plate and ejothem STR insulating plug for flush mounting of STEICO render boards on wooden substrates

Lengths [mm]	80/100/120/140/160/180/200/220/240/260/280/300
Diameter Ø [mm]	screw 6; plate 60
Contents [pcs./box]	100
Recommended anchoring depth [mm]	≥40 in solid timber substrate

**Wide back clamps**

Material	stainless steel
Lengths [mm]	various
Width [mm]	27
Diameter Ø [mm]	≥ 1,8
Recommended anchoring depth [mm]	≥30 in solid timber substrate

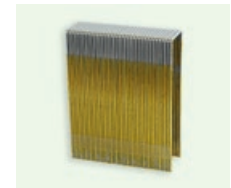

System accessories

STEICOmulti fill

Pressure-resistant joint filler for finishing joints STEICO ETICS and for bonding of STEICOprotect / STEICOprotect dry wood fibre insulation boards with various materials

Contents/cartridge [ml]	310
Contents/cartridge [g]	460
Contents [pcs./box]	12

**STEICOmulti primer**

Primer for adhesion improvement of bonding on porous substrates

Contents/Plastic bottle [g]	1000
Contents [pcs./box]	6

**Joint sealing tape type 15/2-5 / type 15/5-12**

Self-adhesive, pre-compressed joint sealing tape with impregnated side surface for driving rain-tight sealing of connection joints (fully impregnated to DIN 18542 BG1) for STEICO ETICS

Colour	Anthracite
Lengths [m/roll]	type 15/2-5: 18 type 15/5-12: 9
Width [mm]	15
Contents [pcs./box]	10

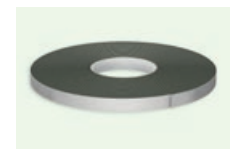
**STEICOmulti tape F**

Joint and connection bonding of STEICO wood fibre insulation boards in combination with STEICOmulti primer and for connection bonding of STEICOfix wood fibre insulation wedge

Lengths [m/roll]	25
Width (Split in backing paper) [mm]	60, 60 (40/20), 100 (50/50), 150 (75/75)
Contents [pcs./box]	10 (60), 6 (100), 4 (150)



STEICOfix

Hydrophobised wood fibre insulation board as an insulating wedge for windowsills with a functional membrane. For use as a second water-bearing layer under window sills.

Lengths [mm]	1350
Thickness / Bevel [mm]	20/100, 20/140, 20/180, 25/200, 30/260
Contents [pcs./package]	25



STEICOfix Sealing set

STEICOfix Wood fibre wedge, Attic profile 1.35 m, STEICOmultip F 60 mm/25 m (20/40 separated), STEICOmultip fill

Packages	STEICOfix		Attic profile		STEICOmultip F	STEICOmultip fill
	Format [mm]	Number [Pcs.]	Lengths [mm]	Number [Pcs.]	Number	Number [Pcs.]
1	1350*100	10	1350	10	1 roll @ 25 m	3
2	1350*140	10	1350	10	1 roll @ 25 m	3
3	1350*180	10	1350	10	1 roll @ 25 m	3
4	1350*200	10	1350	10	1 roll @ 25 m	3
5	1350*260	8	1350	8	1 roll @ 25 m	3



Sanding board and paper

Sanding board	Sanding board with asymmetrical handle for optimum thickness calibration of STEICOprotect / STEICOprotect dry wood fibre insulation boards
Sandpaper	For the sanding board, Grit K16



Checklist „Transfer of base layer ready for rendering“

Checklist „Transfer of base layer ready for rendering“ for the STEICO ETICS

Object identification data

- 1. Address:
.....
.....
- 2. Client:
.....
.....
- 3. Planner:
.....
.....
- 4. Timber construction company:
.....
.....
- 5. Contractor liable for rendering:
.....
.....
- 6. Date/period of building construction:
.....
.....
- 7. Date/period of scheduled rendering:
.....
.....
- Observe the period of exposure to external weathering of up to 4 weeks!
- 8. Comments:
.....
.....
.....
.....
.....
.....

Construction description

- 1. Installation level, if applicable:
.....
.....
- 2. Plane of air tightness:
 Taped:
.....
- 3. Supporting structure:
 Timber frame construction
 Solid timber elements
 Other:
.....
Timber frame center spacing: _____ cm
- 4. Compartment depth, thickness of the element: _____ cm
- 5. Compart insulation:
.....
- 6. Air-injected insulation already installed::
 yes no
If NO, do not use render:
.....
- 7. External planking if necessary:
.....
.....

STEICO render carrying board

1. Board type:
 STEICO*protect* *H* *H dry* *M* *M dry* *L dry*
 STEICO*duo* STEICO*duo dry*
2. Board thickness: _____ mm
3. Board format: _____ mm * _____ mm
 Edge design square tongue and groove
4. Pallet label documented:
 yes no

5. Date of board installation:

Render system

1. Reinforcing compound:
 Please observe a minimum layer thickness of 5 mm.

2. Reinforcement fabric:

3. Any intermediate coating:

4. Finish render:

5. Paint coat, if necessary:

Processing STEICO render carrying board

1. The substrate (solid construction timber/special area/solid timber elements) was tested for dryness prior to assembly or designated as dry:
 yes no
2. Basic processing was carried out according to processing recommendations:
 yes no
 if no, essential deviation:

3. All butt joints >2 mm are finished with STEICO*multi fill*?
 yes no
 if no, position of the joints to be reworked:

4. All butt joints >5 mm are filled with wood fibre insulation and permanently fixed with system-compliant fasteners or STEICO*multi fill*?
 yes no
 if no, position of the joints to be reworked:

5. All joint areas are thickness calibrated by sanding?
 yes no
 if no, position of the joint areas to be reworked:

6. Any imperfections in the surface?
 yes no
 if no, position of the areas to be reworked:

Checklist „Transfer of base layer ready for rendering“

7. Loose fibres on the surface to be rendered were removed with a vacuum or oil-free compressed air and the surface cleaned?

yes no

.....

8. Vertical panel joints with offset (min. 30 cm)?

yes no

if no, determine post-processing:

.....

9. Splash water areas are considered by plinth insulation?

yes no

if no, consider protection by render coating:

.....

if yes, is the plinth insulation arranged according to the processing instructions?

yes no

if no, describe the repair:

.....

10. Structure sealing at least up to 30cm above ground level?

yes no

if no, describe the repair:

.....

11. All component connections are permanently wind and driving rain proof, e.g. by arrangement of a pre-compressed joint sealing tape?

yes no

if no, describe the repair:

.....

Fixing method

1. Fixings used

Wide back staples, stainless (stainless steel)

ejothem STR H screw dowels

ejothem STR U 2G screw anchor

Length:_____ Anchorage depth: _____

for staples, staples arrangement:

cross horizontally

2. Sufficient number of fixings according to directive/approval?

yes no

if no, describe the repair:

.....

3. Fixings set flush with the surface (ejothem STR H screw dowel) or inserted close to the surface, i.e. max. 2 mm deep (wide back clamps)?

yes no

if no, describe the repair:

.....

Checklist „Transfer of base layer ready for rendering“

Connection details

1. All windowsill connections have been carried out according to the processing guidelines?

.....

In particular, permanent water flow into the board profile and driven rain proof connection with suitable joint sealing tape has been ensured?

.....

Sufficient distance between the wood fibre insulation board in the reveal and the front edge of the edge profile for subsequent rendering?

yes no

if no, describe the repair:

.....

2. Floor joint resistant to settling according to processing guidelines and STEICO detail catalogue to avoid creases?

yes no

if no, describe the repair:

.....

3. Method of closing (finishing) the system at the bottom?

- by base rail with push-on profile
- base edge profile subsequently processed by the rendering company according to guidelines

Special features:

.....

4. Are any roller shutter guide rails designed to safely channel water ingress away from the structure?

yes no non-existent

if no, describe the repair/connection:

.....

5. Are any walls that rise up to the roof surface (including dormer walls) permanently and tightly connected with a sheet metal profile?

yes no non-existent

if no, describe connection:

.....

Handover of trades

Before rendering the surfaces, the finishing work listed above must be carried out if necessary. The surfaces must be rendered in suitable weather conditions.

Special attention must be paid to an adequate layer thickness. Only sufficiently dry STEICO wood fiber insulation boards surfaces may be rendered; the material moisture must be checked directly before applying the render (material moisture max. 13 %).

A PE foil test – surface approx. 70*70 cm – can be carried out in the absence of a suitable measuring device. If condensation forms after approx. 24 hours, do not apply a coating.

The wall surfaces to be rendered were thoroughly examined and any improvements are listed in this document.

After their implementation

- can be rendered as per guidelines and state of the art.
- a new construction site appointment is required for the purpose of inspection and handover of the trades.

Date:

.....

for the timber construction company:

.....

for rendering company

.....

for the planning office

.....

Further system partners

With General construction supervision approvals / General design type approval for STEICO render base boards

	<p>AbZ Z-33.47-1171 ETICS with wood fibre insulation boards for use on exterior walls of wood construction type „System Natura“ Board type: STEICO<i>protect H</i> / STEICO<i>protect M</i> / STEICO<i>protect H dry</i> / STEICO<i>protect M dry</i> / STEICO<i>protect L dry</i></p> <p>AbZ / General type approval Z-33.43-1580 ETICS with dowelled and glued wood fibre insulation boards on mineral substrates „System Natura“ Board type: STEICO<i>protect L dry</i></p>
	<p>AbZ Z- 33.47-1087 ETICS with wood fibre insulation boards for use on exterior walls in wood construction „Baumit ÖkoFassade“ Board type: STEICO<i>protect H</i> / STEICO<i>protect M</i> / STEICO<i>protect M dry</i></p>
	<p>AbZ / General design type approval Z-33.47-1624 „Sakret WDVS Holzfaser Holzbau“ composite thermal insulation system in wooden design Board type: STEICO<i>protect H</i> / STEICO<i>protect M dry</i> / STEICO<i>protect L dry</i></p>
	<p>AbZ Z-33.47-1258 WDVS for use on exterior walls in wooden construction „Knauf WARM-WAND Natur S im Holzbau“ Board type: STEICO<i>protect H</i> / STEICO<i>protect M</i></p>
	<p>AbZ Z-33.47-1657 WDVS for application on external walls in wooden construction „SCHWEPA HFD-System“ Board type: STEICO<i>protect M</i></p>
	<p>AbZ Z-33.47-1503 „FIXIT WF – H System“ ETICS on external walls in wooden construction type Board type: STEICO<i>protect H</i></p>
	<p>BBA Agrément Certificate 14/2173 'Warmshell' External Wall Insulation System Board type: STEICO<i>protect H dry</i> / STEICO<i>protect M dry</i></p>

Other system partners with ETA for STEICO render base boards

	<p>ETICS „baumit nature“ (solid constr.) ETA-09/0305, ETA-11/0130, ETA-13/1019 Board type: STEICO<i>protect M dry</i></p> <p>ETICS „baumit nature“ (solid constr.) ETA-09/0305, ETA-11/0130, ETA-13/1019 Board type: STEICO<i>protect M dry</i></p>
---	---

A comprehensive list can be found on our homepage, e.g. under the product STEICO*protect*:

- „Overview of ETICS approvals for timber construction“
- „Overview of ETICS approvals for masonry“

We spend approx. 80% of our lives in enclosed rooms. But are we always aware what we are surrounding ourselves with? STEICO has set itself the target of developing building products which consider the needs of both man and nature. Our products are therefore produced using sustainable natural materials. They help reduce energy use and add considerably to a natural healthy internal climate. Steico insulation and

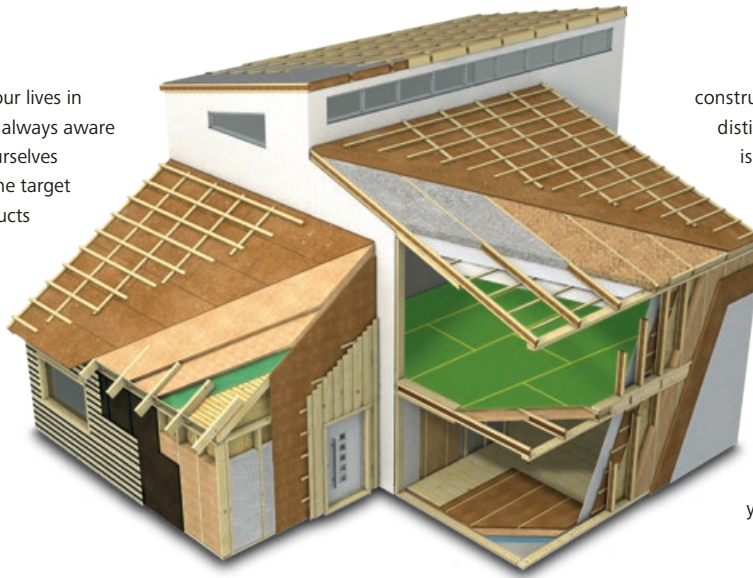

construction materials, carry a number of distinguished 'seals of approval' which is a sign of high quality, healthy and functional building products.

The raw materials used in Steico products are certified by FSC® (Forest Stewardship Council®) and PEFC® (Programme for the Endorsement of Forest Certification®), ensuring a traceable and fully sustainable usage of the raw materials.

STEICO, the number 1 choice for your sustainable building solutions.

Natural insulation and construction systems for new builds and renovations – roof, ceiling, wall and floor



Renewable raw materials without harmful additives



Excellent cold protection in winter



Excellent summer heat protection



Energy saving and increased property worth



Weather tight and breathable



Excellent fire protection



Excellent sound protection



Environmentally friendly and recyclable



Light and easy to handle



Insulation for healthy living



Strong quality control



Compatible insulation and structural building systems



ENGINEERED BY NATURE

Your STEICO Partner

www.steico.com